

DMOS 100mA Low-Dropout Regulator

FEATURES

- **NEW DMOS TOPOLOGY:**
Ultra Low Dropout Voltage:
60mV typ at 100mA
Output capacitor NOT required for stability
- **FAST TRANSIENT RESPONSE**
- **VERY LOW NOISE:** 23 μ Vrms
- **HIGH ACCURACY:** \pm 1.5% max
- **HIGH EFFICIENCY:**
 $I_{GND} = 500\mu A$ at $I_{OUT} = 100mA$
Not Enabled: $I_{GND} = 10nA$
- **2.5V, 2.8V, 2.85V, 3.0V, 3.3V, 5.0V, AND ADJUSTABLE OUTPUT VERSIONS**
- **OTHER OUTPUT VOLTAGES AVAILABLE UPON REQUEST**
- **FOLDBACK CURRENT LIMIT**
- **THERMAL PROTECTION**
- **SMALL SURFACE-MOUNT PACKAGES:**
SOT23-5 and SO-8

APPLICATIONS

- PORTABLE COMMUNICATION DEVICES
- BATTERY-POWERED EQUIPMENT
- PERSONAL DIGITAL ASSISTANTS
- MODEMS
- BAR-CODE SCANNERS
- BACKUP POWER SUPPLIES

DESCRIPTION

The REG101 is a family of low-noise, low-dropout linear regulators with low ground pin current. Its new DMOS topology provides significant improvement over previous designs, including low dropout voltage (only 60mV typ at full load), and better transient performance. In addition, no output capacitor is required for stability, unlike conventional low-dropout regulators that are difficult to compensate and require expensive low ESR capacitors greater than 1 μ F.

Typical ground pin current is only 500 μ A (at $I_{OUT} = 100mA$) and drops to 10nA when not in enabled mode. Unlike regulators with PNP pass devices, quiescent current remains relatively constant over load variation and under dropout conditions.

The REG101 has very low output noise (typically 23 μ Vrms for $V_{OUT} = 3.3V$ with $C_{NR} = 0.01\mu F$), making it ideal for use in portable communications equipment. Accuracy is maintained over temperature, line, and load variations. Key parameters are tested over the specified temperature range ($-40^{\circ}C$ to $+85^{\circ}C$).

The REG101 is well protected—internal circuitry provides a current limit that protects the load from damage. Thermal protection circuitry keeps the chip from being damaged by excessive temperature. The REG101 is available in the SOT23-5 and the SO-8 packages.

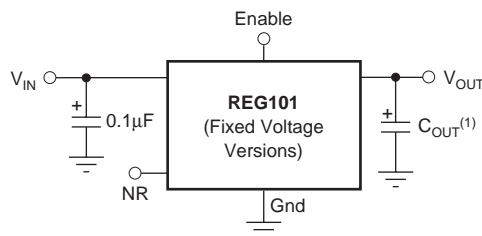

NR = Noise Reduction

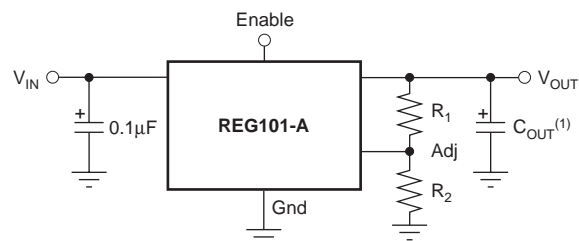

NOTE: (1) Optional.



Please be aware that an important notice concerning availability, standard warranty, and use in critical applications of Texas Instruments semiconductor products and disclaimers thereto appears at the end of this data sheet.

All trademarks are the property of their respective owners.

ABSOLUTE MAXIMUM RATINGS⁽¹⁾

Supply Input Voltage, V_{IN}	-0.3V to 12V
Enable Input Voltage, V_{EN}	-0.3V to V_{IN}
Feedback Voltage, V_{FB}	-0.3V to 6.0V
NR Pin Voltage, V_{NR}	-0.3V to 6.0V
Output Short-Circuit Duration	Indefinite
Operating Temperature Range (T_J)	-55°C to +125°C
Storage Temperature Range (T_A)	-65°C to +150°C
Lead Temperature (soldering, 3s, SOT23-5, and SO-8)	+240°C

NOTE: (1) Stresses above these ratings may cause permanent damage. Exposure to absolute maximum conditions for extended periods may degrade device reliability.



ELECTROSTATIC DISCHARGE SENSITIVITY

This integrated circuit can be damaged by ESD. Texas Instruments recommends that all integrated circuits be handled with appropriate precautions. Failure to observe proper handling and installation procedures can cause damage.

ESD damage can range from subtle performance degradation to complete device failure. Precision integrated circuits may be more susceptible to damage because very small parametric changes could cause the device not to meet its published specifications.

PACKAGE/ORDERING INFORMATION⁽¹⁾

PRODUCT	V_{OUT} ⁽²⁾
REG101xx-yyy/zzz	XX is package designator. YYYY is typical output voltage (5 = 5.0V, 2.85 = 2.85V, A = Adjustable). ZZZ is package quantity.

(1) For the most current package and ordering information, see the Package Option Addendum at the end of this document, or see the TI website at www.ti.com.

(2) Output voltages from 2.5V to 5.1V in 50mV increments are available; minimum order quantities apply. Contact factory for details and availability.

PIN CONFIGURATIONS

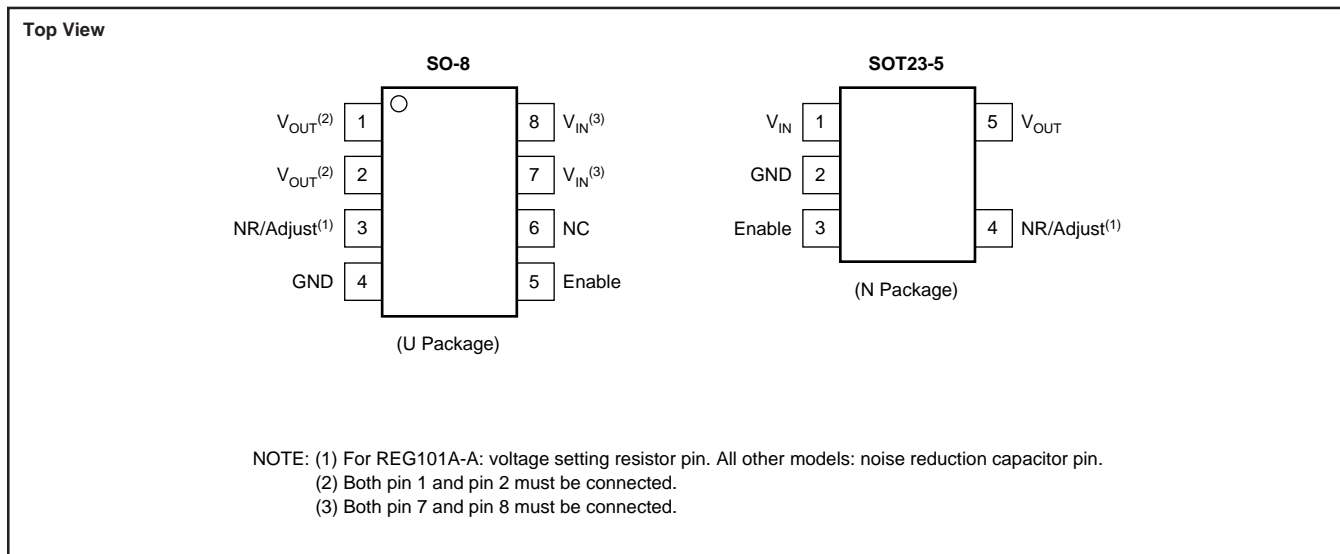

ELECTRICAL CHARACTERISTICS

Boldface limits apply over the specified temperature range, $T_J = -40^{\circ}\text{C}$ to $+85^{\circ}\text{C}$.

At $T_J = +25^{\circ}\text{C}$, $V_{IN} = V_{OUT} + 1\text{V}$ ($V_{OUT} = 2.5\text{V}$ for REG101-A), $V_{ENABLE} = 1.8\text{V}$, $I_{OUT} = 2\text{mA}$, $C_{NR} = 0.01\mu\text{F}$, and $C_{OUT} = 0.1\mu\text{F}^{(1)}$, unless otherwise noted.

PARAMETER	CONDITION	REG101NA REG101UA			UNITS	
		MIN	TYP	MAX		
OUTPUT VOLTAGE						
Output Voltage	V_{OUT}					
REG101-2.5			2.5		V	
REG101-2.8			2.8		V	
REG101-2.85			2.85		V	
REG101-3.0			3.0		V	
REG101-3.3			3.3		V	
REG101-5			5		V	
REG101-A		2.5		5.5	V	
Reference Voltage	V_{REF}		1.267		V	
Adjust Pin Current	I_{ADJ}		0.2	1	μA	
Accuracy			± 0.5	± 1.5	%	
Over Temperature vs Temperature	dV_{OUT}/dT		50	± 2.2	%	
Includes Line and Load		$I_{OUT} = 2\text{mA}$ to 100mA , $V_{IN} = (V_{OUT} + 0.4\text{V})$ to 10V	± 0.8	± 2.0	%	
Over Temperature		$V_{IN} = (V_{OUT} + 0.6\text{V})$ to 10V		± 2.7	%	
DC DROPOUT VOLTAGE⁽²⁾	V_{DROP}					
For all models		$I_{OUT} = 2\text{mA}$	4	10	mV	
		$I_{OUT} = 100\text{mA}$	60	100	mV	
Over Temperature		$I_{OUT} = 100\text{mA}$		130	mV	
VOLTAGE NOISE	V_n					
Without C_{NR}		$f = 10\text{Hz}$ to 100kHz				
		$C_{NR} = 0$, $C_{OUT} = 0$				
With C_{NR} (all fixed voltage models)		$C_{NR} = 0.01\mu\text{F}$, $C_{OUT} = 10\mu\text{F}$				
			$23\mu\text{Vrms}/V \cdot V_{OUT}$		μVrms	
			$7\mu\text{Vrms}/V \cdot V_{OUT}$		μVrms	
OUTPUT CURRENT						
Current Limit ⁽³⁾	I_{CL}		130	170	220	mA
Over Temperature			110		240	mA
Short-Circuit Current	I_{SC}			60		mA
RIPPLE REJECTION						
$f = 120\text{Hz}$		$I_{OUT} = 100\text{mA}$		65		dB
ENABLE CONTROL						
V_{ENABLE} High (output enabled)	V_{ENABLE}		1.8		V_{IN}	V
V_{ENABLE} Low (output disabled)			-0.2		0.5	V
I_{ENABLE} High (output enabled)	I_{ENABLE}	$V_{ENABLE} = 1.8\text{V}$ to V_{IN} , $V_{IN} = 1.8\text{V}$ to $6.5^{(4)}$		1	100	nA
I_{ENABLE} Low (output disabled)		$V_{ENABLE} = 0\text{V}$ to 0.5V		2	100	nA
Output Disable Time		$C_{OUT} = 1.0\mu\text{F}$, $R_{LOAD} = 33\Omega$		200		μs
Output Enable Time		$C_{OUT} = 1.0\mu\text{F}$, $R_{LOAD} = 33\Omega$		1.5		ms
THERMAL SHUTDOWN						
Junction Temperature				160		$^{\circ}\text{C}$
Shutdown				140		$^{\circ}\text{C}$
Reset from Shutdown						
GROUND PIN CURRENT						
Ground Pin Current	I_{GND}	$I_{OUT} = 2\text{mA}$		400	500	μA
		$I_{OUT} = 100\text{mA}$		500	650	μA
Enable Pin Low		$V_{ENABLE} \leq 0.5\text{V}$		0.01	0.2	μA
INPUT VOLTAGE	V_{IN}					
Operating Input Voltage Range ⁽⁵⁾			1.8		10	V
Specified Input Voltage Range		$V_{IN} > 1.8\text{V}$	$V_{OUT} + 0.4$		10	V
Over Temperature		$V_{IN} > 1.8\text{V}$	$V_{OUT} + 0.6$		10	V
TEMPERATURE RANGE						
Specified Range	T_J		-40		+85	$^{\circ}\text{C}$
Operating Range	T_J		-55		+125	$^{\circ}\text{C}$
Storage Range	T_A		-65		+150	$^{\circ}\text{C}$
Thermal Resistance						
SOT23-5 Surface Mount	θ_{JA}	Junction-to-Ambient		200		$^{\circ}\text{C}/\text{W}$
SO-8 Surface Mount	θ_{JA}	Junction-to-Ambient		150		$^{\circ}\text{C}/\text{W}$

- NOTES: (1) The REG101 does not require a minimum output capacitor for stability. However, transient response can be improved with proper capacitor selection.
(2) Dropout voltage is defined as the input voltage minus the output voltage that produces a 2% change in the output voltage from the value at $V_{IN} = V_{OUT} + 1\text{V}$ at fixed load.
(3) Current limit is the output current that produces a 10% change in output voltage from $V_{IN} = V_{OUT} + 1\text{V}$ and $I_{OUT} = 2\text{mA}$.
(4) For $V_{ENABLE} > 6.5\text{V}$, see typical characteristic " I_{ENABLE} vs V_{ENABLE} ".
(5) The REG101 no longer regulates when $V_{IN} < V_{OUT} + V_{DROP(MAX)}$. In drop-out, the impedance from V_{IN} to V_{OUT} is typically less than 1Ω at $T_J = +25^{\circ}\text{C}$.

TYPICAL CHARACTERISTICS

For all models, at $T_J = +25^\circ\text{C}$ and $V_{\text{ENABLE}} = 1.8\text{V}$, unless otherwise noted.

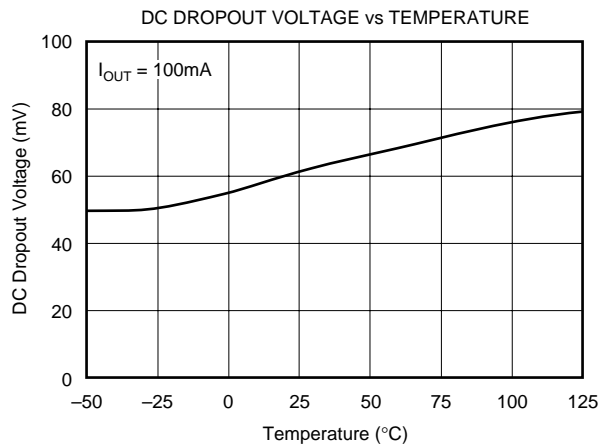
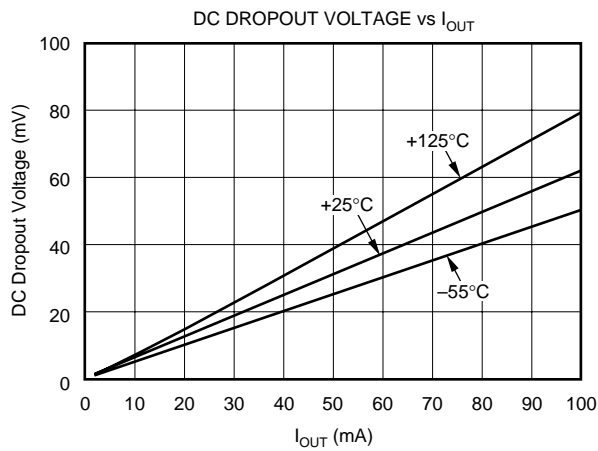
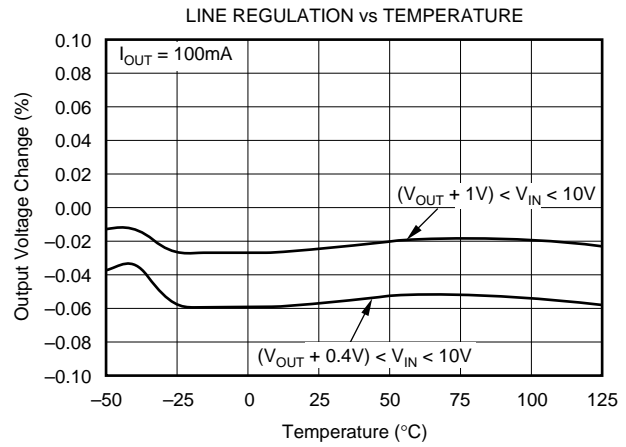
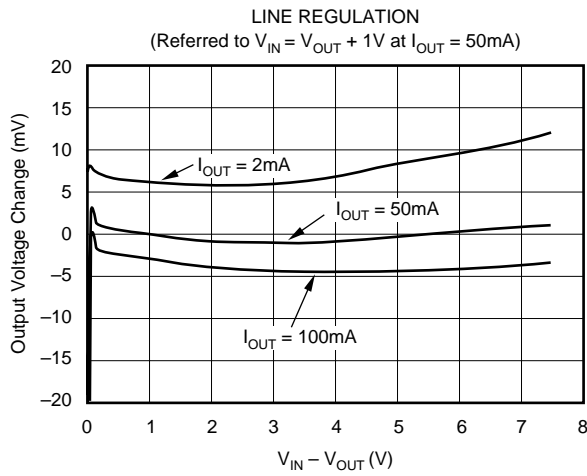
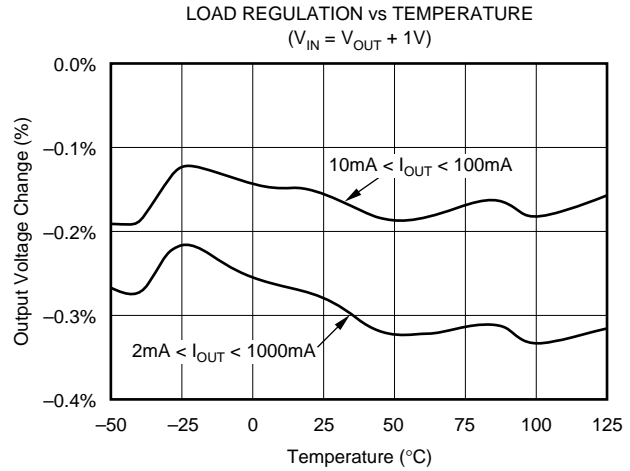
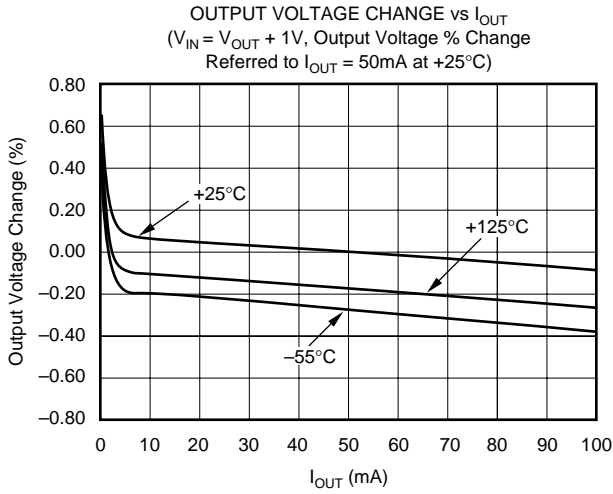

TYPICAL CHARACTERISTICS (Cont.)

For all models, at $T_J = +25^\circ\text{C}$ and $V_{\text{ENABLE}} = 1.8\text{V}$, unless otherwise noted.

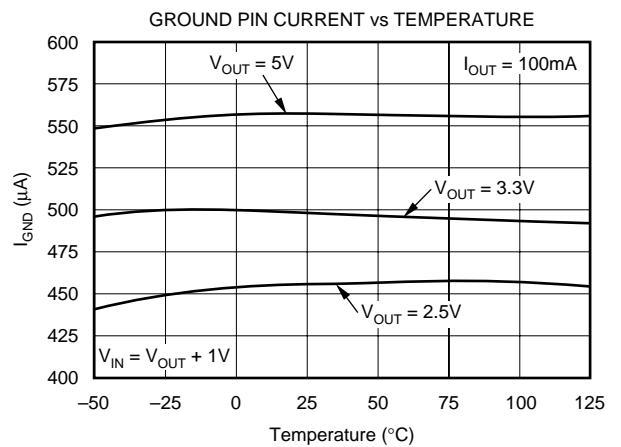
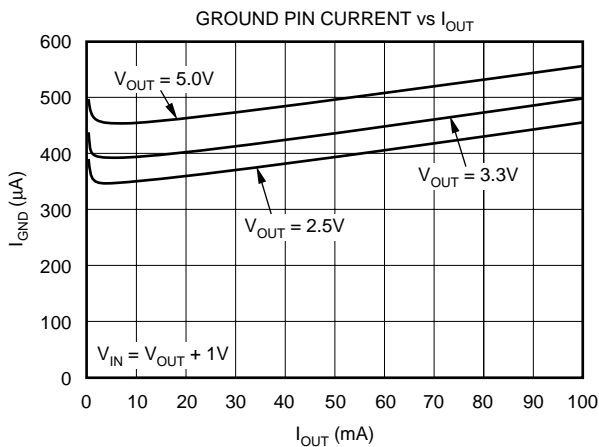
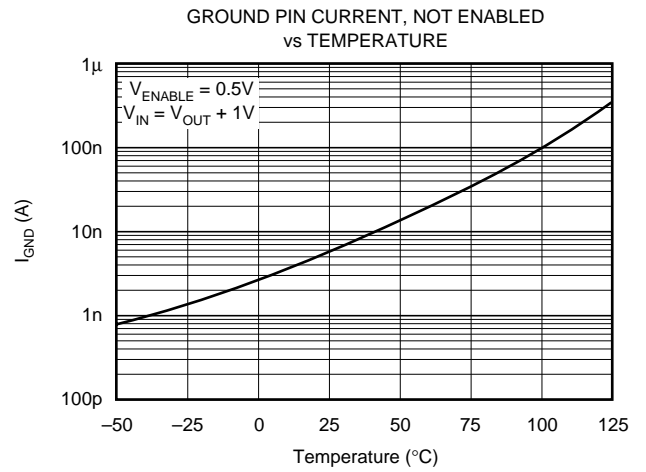
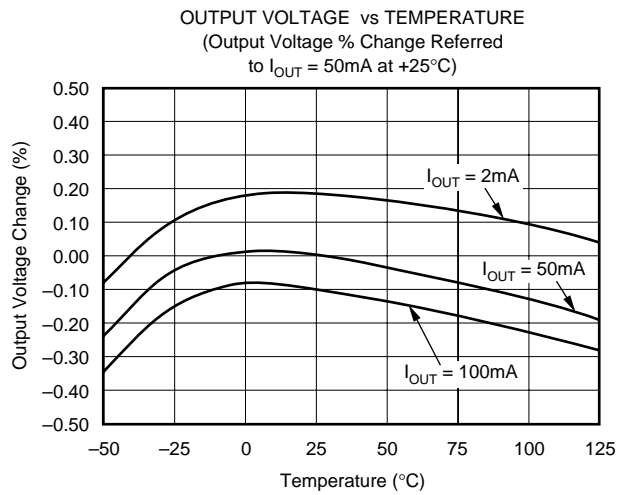
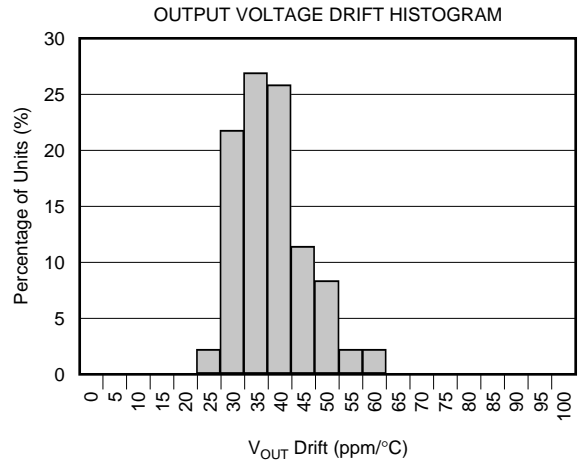
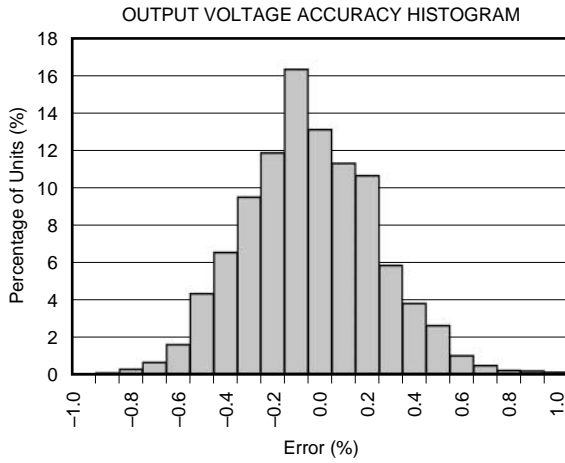

TTYPICAL CHARACTERISTICS (Cont.)

For all models, at $T_J = +25^\circ\text{C}$ and $V_{\text{ENABLE}} = 1.8\text{V}$, unless otherwise noted.

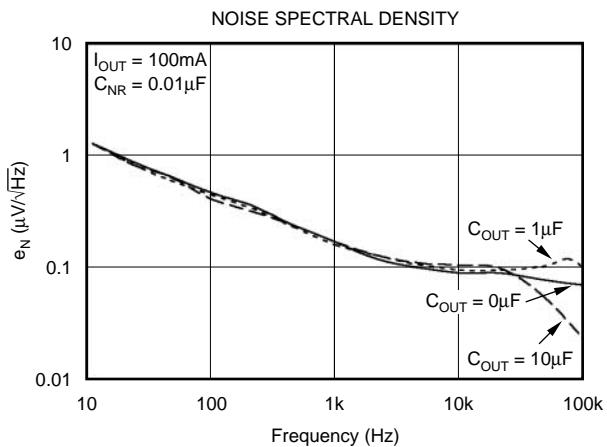
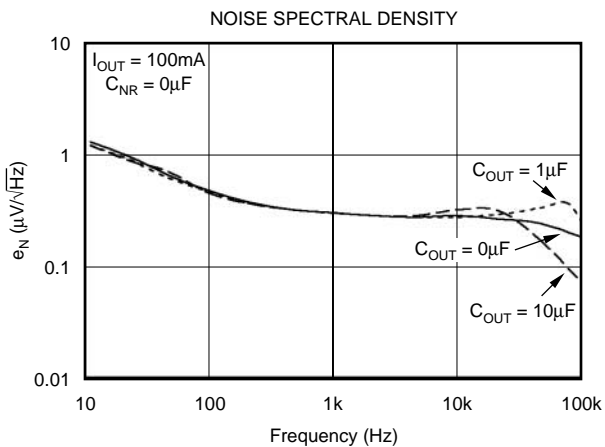
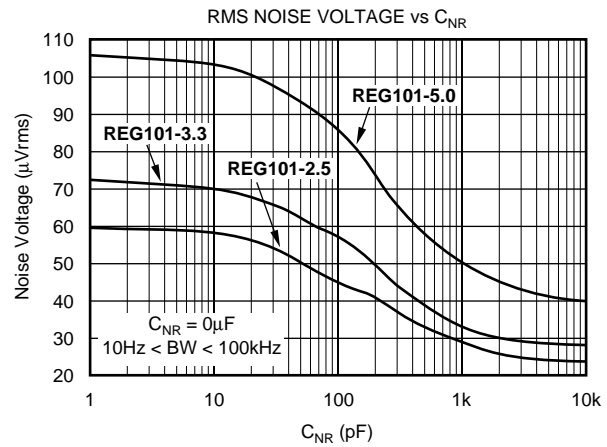
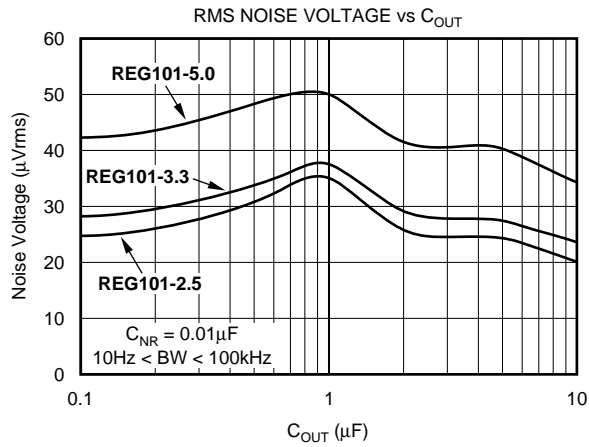
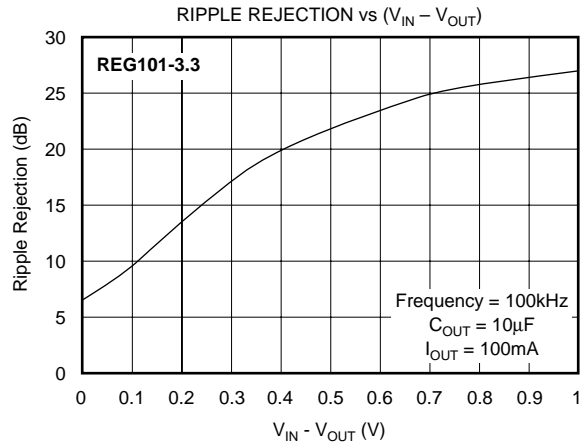
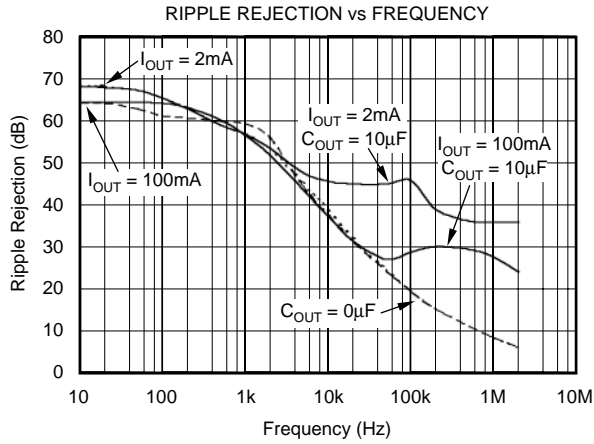

TYPICAL CHARACTERISTICS (Cont.)

For all models, at $T_J = +25^\circ\text{C}$ and $V_{\text{ENABLE}} = 1.8\text{V}$, unless otherwise noted.

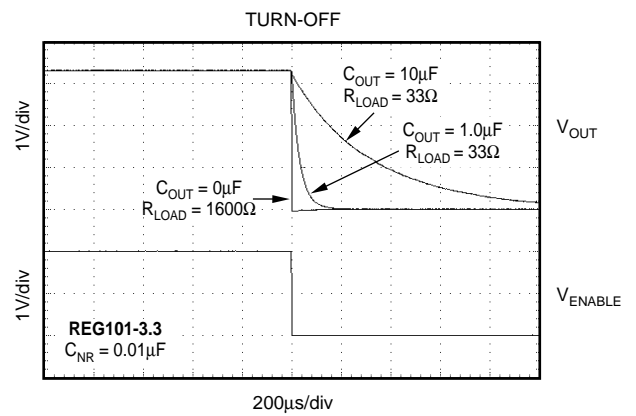
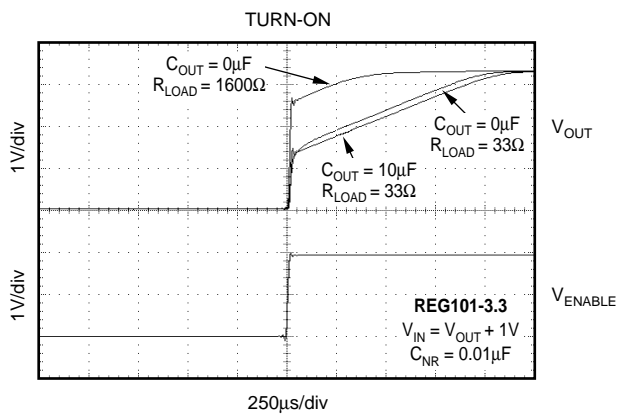
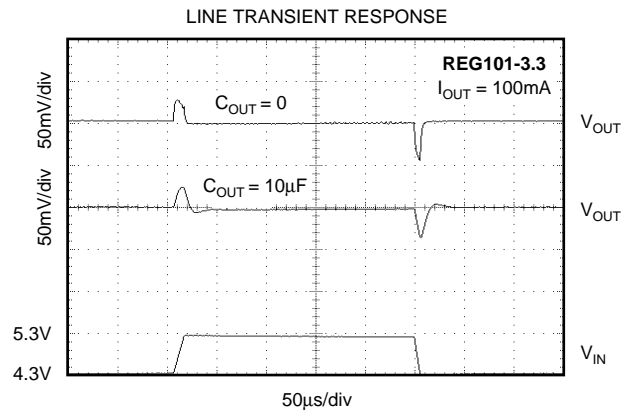
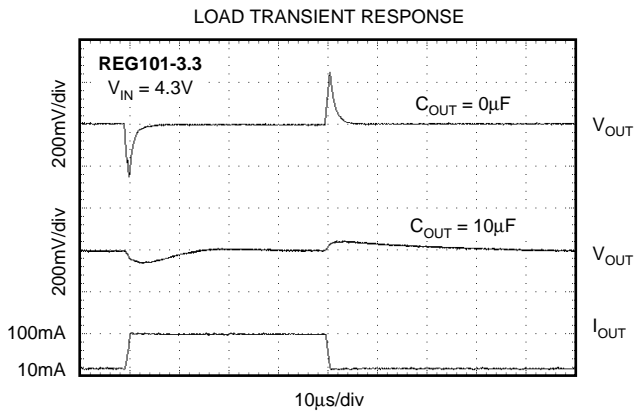
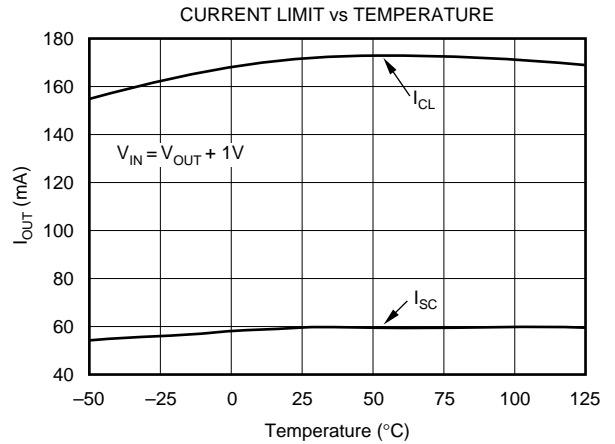
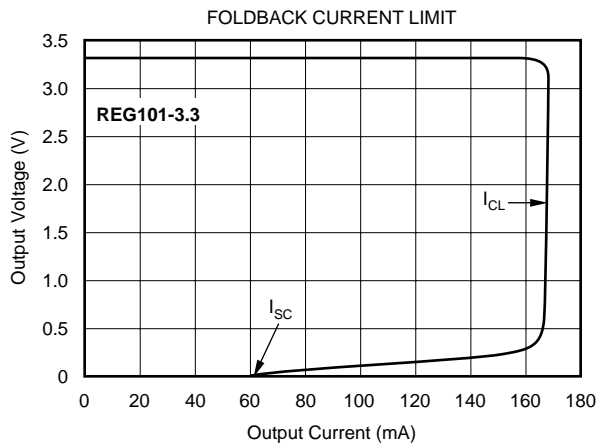

TYPICAL CHARACTERISTICS (Cont.)

For all models, at $T_J = +25^\circ\text{C}$ and $V_{\text{ENABLE}} = 1.8\text{V}$, unless otherwise noted.

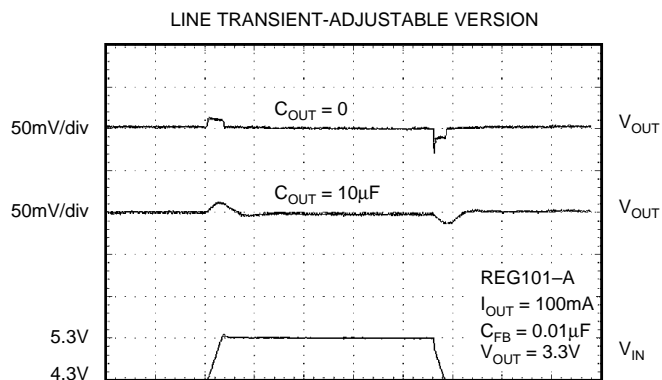
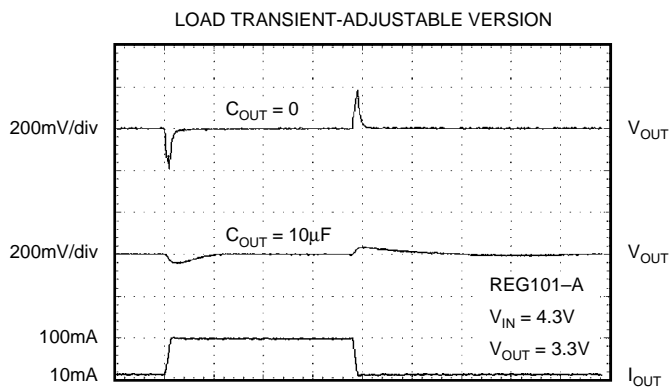
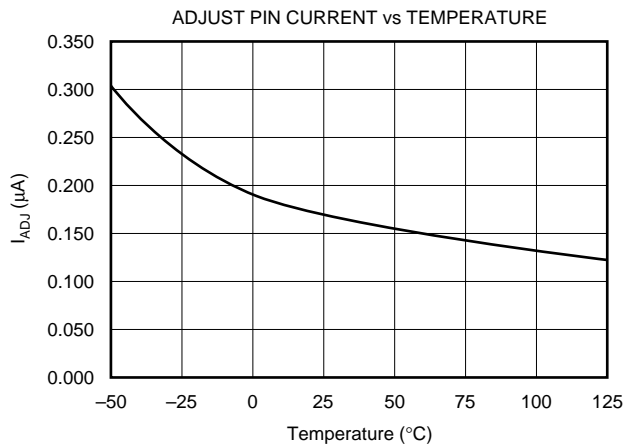
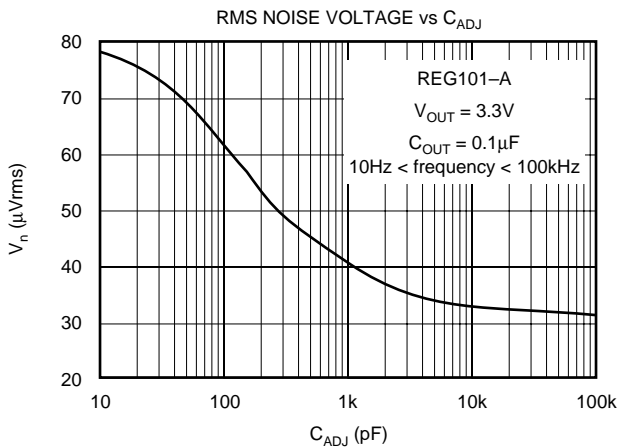
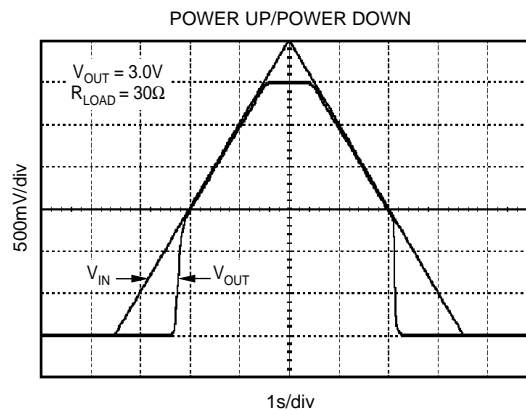
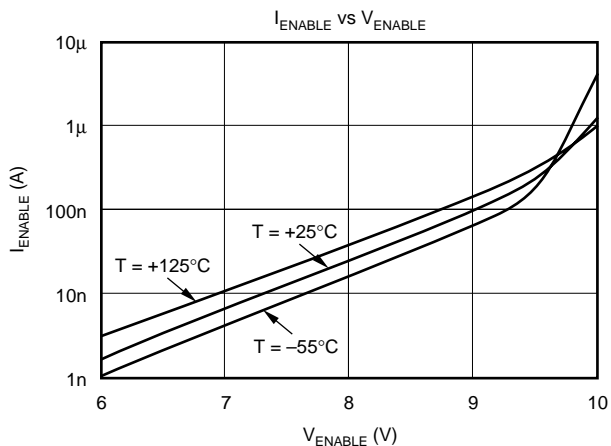

BASIC OPERATION

The REG101 series of LDO (Low Drop-Out) linear regulators offers a wide selection of fixed output voltage versions and an adjustable output version. The REG101 belongs to a family of new generation LDO regulators that utilize a DMOS pass transistor to achieve ultra-low dropout performance and freedom from output capacitor constraints. Ground pin current remains under 650µA over all line, load, and temperature conditions. All versions have thermal and over-current protection, including foldback current limit.

The REG101 does not require an output capacitor for regulator stability and is stable over most output currents and with almost any value and type of output capacitor up to 10µF or more. For applications where the regulator output current drops below several milliamps, stability can be enhanced by: adding a 1kΩ to 2kΩ load resistor; using capacitance values less than 10µF; or keeping the effective series resistance greater than 0.05Ω including the capacitor's ESR and parasitic resistance in printed circuit board traces, solder joints, and sockets.

Although an input capacitor is not required, it is good analog design practice to connect a 0.1µF low ESR capacitor across

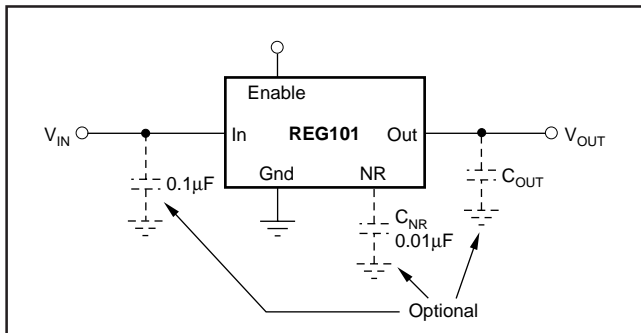

FIGURE 1. Fixed Voltage Nominal Circuit for REG101.

the input supply voltage. This is recommended to improve ripple rejection by reducing input voltage ripple.

Figure 1 shows the basic circuit connections for the fixed voltage models. Figure 2 gives the connections for the adjustable output version (REG101A) and example resistor values for some commonly used output voltages. Values for other voltages can be calculated from the equation shown in Figure 2.

INTERNAL CURRENT LIMIT

The REG101 internal current limit has a typical value of 170mA. A foldback feature limits the short-circuit current to a typical short-circuit value of 60mA. This helps to protect the regulator from damage under all load conditions. A characteristic of V_{OUT} versus I_{OUT} is given in Figure 3 and in the Typical Characteristics section.

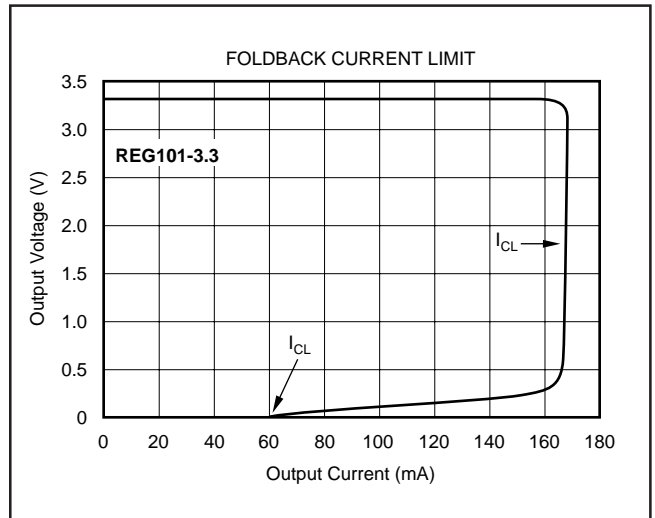

FIGURE 3. Foldback Current Limit of the REG101-3.3 at 25°C.

Pin numbers for SOT23 package.

$$V_{OUT} = (1 + R_1/R_2) \cdot 1.267V$$

To reduce current through divider, increase resistor values (see table at right).
 As the impedance of the resistor divider increases, I_{ADJ} (~200nA) may introduce an error.
 C_{FB} improves noise and transient response.

EXAMPLE RESISTOR VALUES		
V _{OUT} (V)	R ₁ (W) ⁽¹⁾	R ₂ (Ω) ⁽¹⁾
2.5	11.3k	11.5k
	1.13k	1.15k
3.0	15.8k	11.5k
	1.58k	1.15k
3.3	18.7k	11.5k
	1.87k	1.15k
5.0	34.0k	11.5k
	3.40k	1.15k

NOTE: (1) Resistors are standard 1% values.

FIGURE 2. Adjustable Voltage Circuit for REG101A.

ENABLE

The Enable pin is active HIGH and compatible with standard TTL-CMOS levels. Inputs below 0.5V (max) turn the regulator off and all circuitry is disabled. Under this condition, ground pin current drops to approximately 10nA. When a pull-up resistor is used, and operation down to $V_{IN} = 1.8V$ is required, use values $< 50k\Omega$.

OUTPUT NOISE

A precision band-gap reference is used for the internal reference voltage, V_{REF} . This reference is the dominant noise source within the REG101 and it generates approximately $29\mu V_{rms}$ in the 10Hz to 100kHz bandwidth at the reference output. The regulator control loop gains up the reference noise, so that the noise voltage of the regulator is approximately given by:

$$V_N = 29\mu V_{rms} \frac{R_1 + R_2}{R_2} = 29\mu V_{rms} \cdot \frac{V_{OUT}}{V_{REF}}$$

Since the value of V_{REF} is 1.267V, this relationship reduces to:

$$V_N = 23 \frac{\mu V_{rms}}{V} \cdot V_{OUT}$$

Connecting a capacitor, C_{NR} , from the Noise Reduction (NR) pin to ground, as shown in Figure 4, forms a low-pass filter for the voltage reference. For $C_{NR} = 10nF$, the total noise in the 10Hz to 100kHz bandwidth is reduced by approximately a factor of 2.8 for $V_O = 3.3V$. This noise reduction effect is shown in Figure 5 and as “RMS Noise Voltage vs CNR” in the Typical Characteristics section.

Noise can be further reduced by carefully choosing an output capacitor, C_{OUT} . Best overall noise performance is

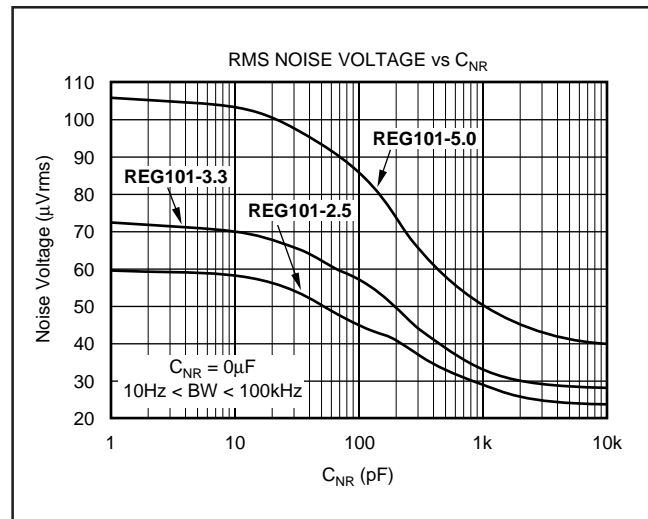

FIGURE 5. Output Noise versus Noise Reduction Capacitor.

achieved with very low ($< 0.22\mu F$) or very high ($> 2.2\mu F$) values of C_{OUT} . See “RMS Noise Voltage vs C_{OUT} ” in the Typical Characteristics section.

The REG101 utilizes an internal charge pump to develop an internal supply voltage sufficient to drive the gate of the DMOS pass element above V_{IN} . The charge-pump switching noise (nominal switching frequency = 2MHz) is not measurable at the output of the regulator over most values of C_{OUT} and I_{OUT} .

The REG101 adjustable version does not have the noise-reduction pin available, however, the adjust pin is the summing junction of the error amplifier. A capacitor, C_{FB} , connected from the output to the adjust pin will reduce both the output noise and the peak error from a load transient. See the typical characteristics for output noise performance.

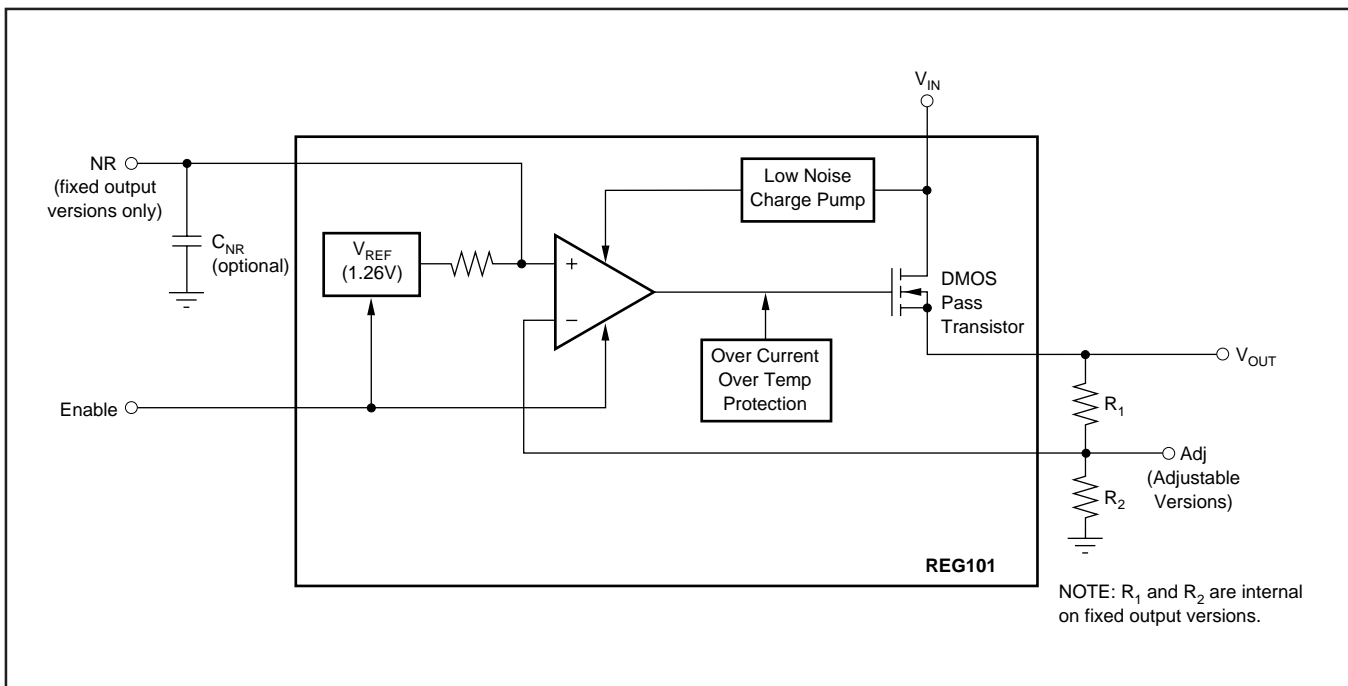

FIGURE 4. Block Diagram.

DROP-OUT VOLTAGE

The REG101 uses an N-channel DMOS as the “pass” element. When the input voltage is within a few tens of millivolts of the output voltage, the DMOS device behaves like a resistor. Therefore, for low values of V_{IN} to V_{OUT} , the regulator’s input-to-output resistance is the $R_{ds(ON)}$ of the DMOS pass element (typically 600m Ω). For static (DC) loads, the REG101 will typically maintain regulation down to V_{IN} to V_{OUT} voltage drop of 60mV at full rated output current. In Figure 6, the bottom line (DC dropout) shows the minimum V_{IN} to V_{OUT} voltage drop required to prevent drop-out under DC load conditions.

For large step changes in load current, the REG101 requires a larger voltage drop across it to avoid degraded transient response. The boundary of this “transient drop-out” region is shown as the top line in Figure 6. Values of V_{IN} to V_{OUT} voltage drop above this line insure normal transient response.

In the transient dropout region between “DC” and “Transient”, transient response recovery time increases. The time required to recover from a load transient is a function of both the magnitude and rate of the step change in load current and the available “headroom” V_{IN} to V_{OUT} voltage drop. Under worst-case conditions (full-scale load change with V_{IN} to V_{OUT} voltage drop close to DC dropout levels), the REG101 can take several hundred microseconds to re-enter the specified window of regulation.

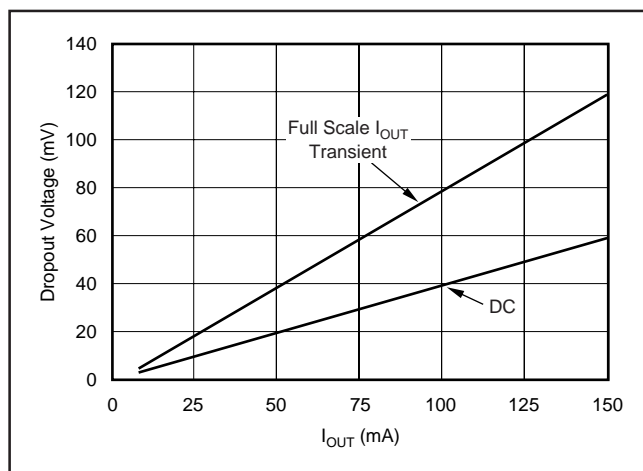

FIGURE 6. Transient and DC Dropout.

TRANSIENT RESPONSE

The REG101 response to transient line and load conditions improves at lower output voltages. The addition of a capacitor (nominal value 0.47 μ F) from the output pin to ground may improve the transient response. In the adjustable version, the addition of a capacitor, C_{FB} (nominal value 10nF), from the output to the adjust pin will also improve the transient response.

THERMAL PROTECTION

The REG101 has thermal shutdown circuitry that protects the regulator from damage. The thermal protection circuitry disables the output when the junction temperature reaches approximately 160°C, allowing the device to cool. When the junction temperature cools to approximately 140°C, the output circuitry is again enabled. Depending on various conditions, the thermal protection circuit may cycle on and off. This limits the dissipation of the regulator, but may have an undesirable effect on the load.

Any tendency to activate the thermal protection circuit indicates excessive power dissipation or an inadequate heat sink. For reliable operation, junction temperature should be limited to 125°C, maximum. To estimate the margin of safety in a complete design (including heat sink), increase the ambient temperature until the thermal protection is triggered. Use worst-case loads and signal conditions. For good reliability, thermal protection should trigger more than 35°C above the maximum expected ambient condition of your application. This produces a worst-case junction temperature of 125°C at the highest expected ambient temperature and worst-case load.

The internal protection circuitry of the REG101 has been designed to protect against overload conditions. It was not intended to replace proper heat sinking. Continuously running the REG101 into thermal shutdown will degrade reliability.

POWER DISSIPATION

The REG101 is available in two different package configurations. The ability to remove heat from the die is different for each package type and, therefore, presents different considerations in the printed circuit board (PCB) layout. The PCB area around the device that is free of other components moves the heat from the device to the ambient air. While it is difficult to impossible to quantify all of the variables in a thermal design of this type, performance data for several configurations are shown in Figure 7.

Power dissipation depends on input voltage, load condition, and duty cycle. Power dissipation is equal to the product of the average output current times the voltage across the output element, V_{IN} to V_{OUT} voltage drop.

$$P_D = (V_{IN} - V_{OUT}) \cdot I_{OUT(AVG)}$$

Power dissipation can be minimized by using the lowest possible input voltage necessary to assure the required output voltage.

REGULATOR MOUNTING

Solder pad footprint recommendations for the various REG101 devices are presented in the Application Bulletin AB-132, "Solder Pad Recommendations for Surface-Mount Devices" (SBFA015), available from the Texas Instruments web site (www.ti.com).

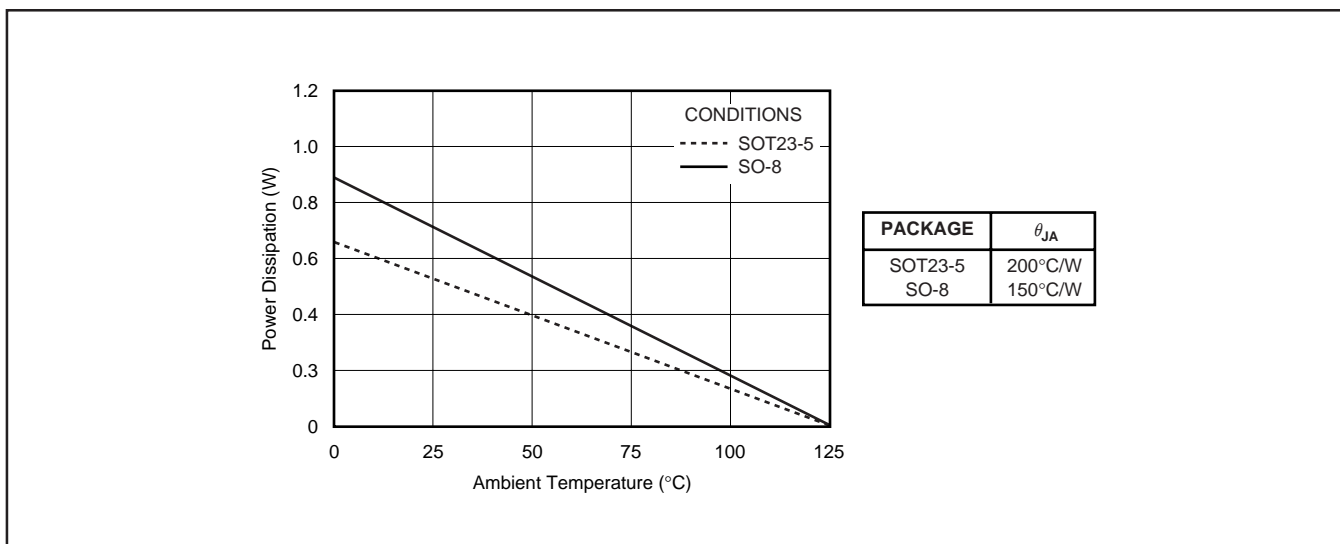

FIGURE 7. Maximum Power Dissipation versus Ambient Temperature for the Various Packages.

PACKAGING INFORMATION

Orderable Device	Status ⁽¹⁾	Package Type	Package Drawing	Pins	Package Qty	Eco Plan ⁽²⁾	Lead/Ball Finish	MSL Peak Temp ⁽³⁾
REG101NA-2.5/250	ACTIVE	SOT-23	DBV	5	250	Green (RoHS & no Sb/Br)	CU NIPDAU	Level-1-260C-UNLIM
REG101NA-2.5/250G4	ACTIVE	SOT-23	DBV	5	250	Green (RoHS & no Sb/Br)	CU NIPDAU	Level-1-260C-UNLIM
REG101NA-2.5/3K	ACTIVE	SOT-23	DBV	5	3000	Green (RoHS & no Sb/Br)	CU NIPDAU	Level-1-260C-UNLIM
REG101NA-2.5/3KG4	ACTIVE	SOT-23	DBV	5	3000	Green (RoHS & no Sb/Br)	CU NIPDAU	Level-1-260C-UNLIM
REG101NA-2.8/250	ACTIVE	SOT-23	DBV	5	250	Green (RoHS & no Sb/Br)	CU NIPDAU	Level-1-260C-UNLIM
REG101NA-2.8/250G4	ACTIVE	SOT-23	DBV	5	250	Green (RoHS & no Sb/Br)	CU NIPDAU	Level-1-260C-UNLIM
REG101NA-2.8/3K	ACTIVE	SOT-23	DBV	5	3000	Green (RoHS & no Sb/Br)	CU NIPDAU	Level-1-260C-UNLIM
REG101NA-2.8/3KG4	ACTIVE	SOT-23	DBV	5	3000	Green (RoHS & no Sb/Br)	CU NIPDAU	Level-1-260C-UNLIM
REG101NA-2.85/250	ACTIVE	SOT-23	DBV	5	250	Green (RoHS & no Sb/Br)	CU NIPDAU	Level-1-260C-UNLIM
REG101NA-2.85/3K	ACTIVE	SOT-23	DBV	5	3000	Green (RoHS & no Sb/Br)	CU NIPDAU	Level-1-260C-UNLIM
REG101NA-2.85/3KG4	ACTIVE	SOT-23	DBV	5	3000	Green (RoHS & no Sb/Br)	CU NIPDAU	Level-1-260C-UNLIM
REG101NA-3.3/250	ACTIVE	SOT-23	DBV	5	250	Green (RoHS & no Sb/Br)	CU NIPDAU	Level-1-260C-UNLIM
REG101NA-3.3/250G4	ACTIVE	SOT-23	DBV	5	250	Green (RoHS & no Sb/Br)	CU NIPDAU	Level-1-260C-UNLIM
REG101NA-3.3/3K	ACTIVE	SOT-23	DBV	5	3000	Green (RoHS & no Sb/Br)	CU NIPDAU	Level-1-260C-UNLIM
REG101NA-3.3/3KG4	ACTIVE	SOT-23	DBV	5	3000	Green (RoHS & no Sb/Br)	CU NIPDAU	Level-1-260C-UNLIM
REG101NA-3/250	ACTIVE	SOT-23	DBV	5	250	Green (RoHS & no Sb/Br)	CU NIPDAU	Level-1-260C-UNLIM
REG101NA-3/250G4	ACTIVE	SOT-23	DBV	5	250	Green (RoHS & no Sb/Br)	CU NIPDAU	Level-1-260C-UNLIM
REG101NA-3/3K	ACTIVE	SOT-23	DBV	5	3000	Green (RoHS & no Sb/Br)	CU NIPDAU	Level-1-260C-UNLIM
REG101NA-3/3KG4	ACTIVE	SOT-23	DBV	5	3000	Green (RoHS & no Sb/Br)	CU NIPDAU	Level-1-260C-UNLIM
REG101NA-5/250	ACTIVE	SOT-23	DBV	5	250	Green (RoHS & no Sb/Br)	CU NIPDAU	Level-1-260C-UNLIM
REG101NA-5/250G4	ACTIVE	SOT-23	DBV	5	250	Green (RoHS & no Sb/Br)	CU NIPDAU	Level-1-260C-UNLIM
REG101NA-5/3K	ACTIVE	SOT-23	DBV	5	3000	Green (RoHS & no Sb/Br)	CU NIPDAU	Level-1-260C-UNLIM
REG101NA-5/3KG4	ACTIVE	SOT-23	DBV	5	3000	Green (RoHS & no Sb/Br)	CU NIPDAU	Level-1-260C-UNLIM
REG101NA-A/250	ACTIVE	SOT-23	DBV	5	250	Green (RoHS & no Sb/Br)	CU NIPDAU	Level-1-260C-UNLIM
REG101NA-A/250G4	ACTIVE	SOT-23	DBV	5	250	Green (RoHS & no Sb/Br)	CU NIPDAU	Level-1-260C-UNLIM

Orderable Device	Status ⁽¹⁾	Package Type	Package Drawing	Pins	Package Qty	Eco Plan ⁽²⁾	Lead/Ball Finish	MSL Peak Temp ⁽³⁾
REG101NA-A/3K	ACTIVE	SOT-23	DBV	5	3000	Green (RoHS & no Sb/Br)	CU NIPDAU	Level-1-260C-UNLIM
REG101NA-A/3KG4	ACTIVE	SOT-23	DBV	5	3000	Green (RoHS & no Sb/Br)	CU NIPDAU	Level-1-260C-UNLIM
REG101NA2.85/250G4	ACTIVE	SOT-23	DBV	5	250	Green (RoHS & no Sb/Br)	CU NIPDAU	Level-1-260C-UNLIM
REG101UA-2.5	ACTIVE	SOIC	D	8	75	Green (RoHS & no Sb/Br)	CU NIPDAU	Level-2-260C-1 YEAR
REG101UA-2.5G4	ACTIVE	SOIC	D	8	75	Green (RoHS & no Sb/Br)	CU NIPDAU	Level-2-260C-1 YEAR
REG101UA-2.8	ACTIVE	SOIC	D	8	75	Green (RoHS & no Sb/Br)	CU NIPDAU	Level-2-260C-1 YEAR
REG101UA-2.8/2K5	ACTIVE	SOIC	D	8	2500	Green (RoHS & no Sb/Br)	CU NIPDAU	Level-2-260C-1 YEAR
REG101UA-2.8/2K5G4	ACTIVE	SOIC	D	8	2500	Green (RoHS & no Sb/Br)	CU NIPDAU	Level-2-260C-1 YEAR
REG101UA-2.85	ACTIVE	SOIC	D	8	75	Green (RoHS & no Sb/Br)	CU NIPDAU	Level-2-260C-1 YEAR
REG101UA-2.85G4	ACTIVE	SOIC	D	8	75	Green (RoHS & no Sb/Br)	CU NIPDAU	Level-2-260C-1 YEAR
REG101UA-2.8G4	ACTIVE	SOIC	D	8	75	Green (RoHS & no Sb/Br)	CU NIPDAU	Level-2-260C-1 YEAR
REG101UA-3	ACTIVE	SOIC	D	8	75	Green (RoHS & no Sb/Br)	CU NIPDAU	Level-2-260C-1 YEAR
REG101UA-3.3	ACTIVE	SOIC	D	8	75	Green (RoHS & no Sb/Br)	CU NIPDAU	Level-2-260C-1 YEAR
REG101UA-3.3/2K5	ACTIVE	SOIC	D	8	2500	Green (RoHS & no Sb/Br)	CU NIPDAU	Level-2-260C-1 YEAR
REG101UA-3.3/2K5G4	ACTIVE	SOIC	D	8	2500	Green (RoHS & no Sb/Br)	CU NIPDAU	Level-2-260C-1 YEAR
REG101UA-3.3G4	ACTIVE	SOIC	D	8	75	Green (RoHS & no Sb/Br)	CU NIPDAU	Level-2-260C-1 YEAR
REG101UA-3G4	ACTIVE	SOIC	D	8	75	Green (RoHS & no Sb/Br)	CU NIPDAU	Level-2-260C-1 YEAR
REG101UA-5	ACTIVE	SOIC	D	8	75	Green (RoHS & no Sb/Br)	CU NIPDAU	Level-2-260C-1 YEAR
REG101UA-5/2K5	ACTIVE	SOIC	D	8	2500	Green (RoHS & no Sb/Br)	CU NIPDAU	Level-2-260C-1 YEAR
REG101UA-5/2K5G4	ACTIVE	SOIC	D	8	2500	Green (RoHS & no Sb/Br)	CU NIPDAU	Level-2-260C-1 YEAR
REG101UA-5G4	ACTIVE	SOIC	D	8	75	Green (RoHS & no Sb/Br)	CU NIPDAU	Level-2-260C-1 YEAR
REG101UA-A	ACTIVE	SOIC	D	8	75	Green (RoHS & no Sb/Br)	CU NIPDAU	Level-2-260C-1 YEAR
REG101UA-AG4	ACTIVE	SOIC	D	8	75	Green (RoHS & no Sb/Br)	CU NIPDAU	Level-2-260C-1 YEAR

⁽¹⁾ The marketing status values are defined as follows:

ACTIVE: Product device recommended for new designs.

LIFEBUY: TI has announced that the device will be discontinued, and a lifetime-buy period is in effect.

NRND: Not recommended for new designs. Device is in production to support existing customers, but TI does not recommend using this part in a new design.

PREVIEW: Device has been announced but is not in production. Samples may or may not be available.

OBSOLETE: TI has discontinued the production of the device.

⁽²⁾ Eco Plan - The planned eco-friendly classification: Pb-Free (RoHS), Pb-Free (RoHS Exempt), or Green (RoHS & no Sb/Br) - please check <http://www.ti.com/productcontent> for the latest availability information and additional product content details.

TBD: The Pb-Free/Green conversion plan has not been defined.

Pb-Free (RoHS): TI's terms "Lead-Free" or "Pb-Free" mean semiconductor products that are compatible with the current RoHS requirements for all 6 substances, including the requirement that lead not exceed 0.1% by weight in homogeneous materials. Where designed to be soldered at high temperatures, TI Pb-Free products are suitable for use in specified lead-free processes.

Pb-Free (RoHS Exempt): This component has a RoHS exemption for either 1) lead-based flip-chip solder bumps used between the die and package, or 2) lead-based die adhesive used between the die and leadframe. The component is otherwise considered Pb-Free (RoHS compatible) as defined above.

Green (RoHS & no Sb/Br): TI defines "Green" to mean Pb-Free (RoHS compatible), and free of Bromine (Br) and Antimony (Sb) based flame retardants (Br or Sb do not exceed 0.1% by weight in homogeneous material)

⁽³⁾ MSL, Peak Temp. -- The Moisture Sensitivity Level rating according to the JEDEC industry standard classifications, and peak solder temperature.

Important Information and Disclaimer:The information provided on this page represents TI's knowledge and belief as of the date that it is provided. TI bases its knowledge and belief on information provided by third parties, and makes no representation or warranty as to the accuracy of such information. Efforts are underway to better integrate information from third parties. TI has taken and continues to take reasonable steps to provide representative and accurate information but may not have conducted destructive testing or chemical analysis on incoming materials and chemicals. TI and TI suppliers consider certain information to be proprietary, and thus CAS numbers and other limited information may not be available for release.

In no event shall TI's liability arising out of such information exceed the total purchase price of the TI part(s) at issue in this document sold by TI to Customer on an annual basis.

TAPE AND REEL INFORMATION



QUADRANT ASSIGNMENTS FOR PIN 1 ORIENTATION IN TAPE



*All dimensions are nominal

Device	Package Type	Package Drawing	Pins	SPQ	Reel Diameter (mm)	Reel Width W1 (mm)	A0 (mm)	B0 (mm)	K0 (mm)	P1 (mm)	W (mm)	Pin1 Quadrant
REG101NA-2.5/250	SOT-23	DBV	5	250	179.0	8.4	3.2	3.2	1.4	4.0	8.0	Q3
REG101NA-2.5/3K	SOT-23	DBV	5	3000	179.0	8.4	3.2	3.2	1.4	4.0	8.0	Q3
REG101NA-2.8/250	SOT-23	DBV	5	250	179.0	8.4	3.2	3.2	1.4	4.0	8.0	Q3
REG101NA-2.8/3K	SOT-23	DBV	5	3000	179.0	8.4	3.2	3.2	1.4	4.0	8.0	Q3
REG101NA-2.85/250	SOT-23	DBV	5	250	179.0	8.4	3.2	3.2	1.4	4.0	8.0	Q3
REG101NA-2.85/3K	SOT-23	DBV	5	3000	179.0	8.4	3.2	3.2	1.4	4.0	8.0	Q3
REG101NA-3.3/250	SOT-23	DBV	5	250	179.0	8.4	3.2	3.2	1.4	4.0	8.0	Q3
REG101NA-3.3/3K	SOT-23	DBV	5	3000	179.0	8.4	3.2	3.2	1.4	4.0	8.0	Q3
REG101NA-3/250	SOT-23	DBV	5	250	179.0	8.4	3.2	3.2	1.4	4.0	8.0	Q3
REG101NA-3/3K	SOT-23	DBV	5	3000	179.0	8.4	3.2	3.2	1.4	4.0	8.0	Q3
REG101NA-5/250	SOT-23	DBV	5	250	179.0	8.4	3.2	3.2	1.4	4.0	8.0	Q3
REG101NA-5/3K	SOT-23	DBV	5	3000	179.0	8.4	3.2	3.2	1.4	4.0	8.0	Q3
REG101NA-A/250	SOT-23	DBV	5	250	179.0	8.4	3.2	3.2	1.4	4.0	8.0	Q3
REG101NA-A/3K	SOT-23	DBV	5	3000	179.0	8.4	3.2	3.2	1.4	4.0	8.0	Q3
REG101UA-2.8/2K5	SOIC	D	8	2500	330.0	12.4	6.4	5.2	2.1	8.0	12.0	Q1
REG101UA-3.3/2K5	SOIC	D	8	2500	330.0	12.4	6.4	5.2	2.1	8.0	12.0	Q1
REG101UA-5/2K5	SOIC	D	8	2500	330.0	12.4	6.4	5.2	2.1	8.0	12.0	Q1

TAPE AND REEL BOX DIMENSIONS

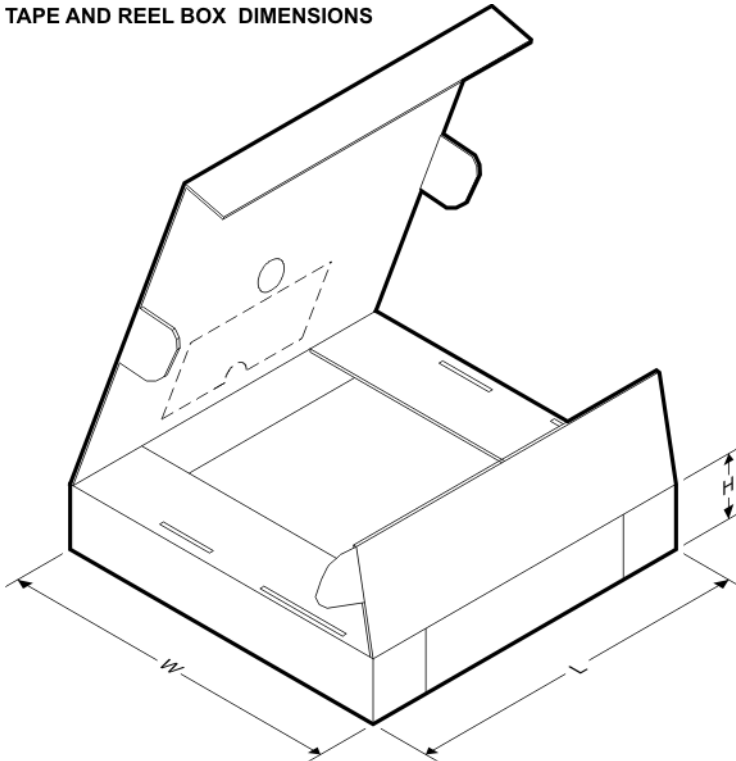

*All dimensions are nominal

Device	Package Type	Package Drawing	Pins	SPQ	Length (mm)	Width (mm)	Height (mm)
REG101NA-2.5/250	SOT-23	DBV	5	250	195.0	200.0	45.0
REG101NA-2.5/3K	SOT-23	DBV	5	3000	195.0	200.0	45.0
REG101NA-2.8/250	SOT-23	DBV	5	250	195.0	200.0	45.0
REG101NA-2.8/3K	SOT-23	DBV	5	3000	195.0	200.0	45.0
REG101NA-2.85/250	SOT-23	DBV	5	250	195.0	200.0	45.0
REG101NA-2.85/3K	SOT-23	DBV	5	3000	195.0	200.0	45.0
REG101NA-3.3/250	SOT-23	DBV	5	250	195.0	200.0	45.0
REG101NA-3.3/3K	SOT-23	DBV	5	3000	195.0	200.0	45.0
REG101NA-3/250	SOT-23	DBV	5	250	195.0	200.0	45.0
REG101NA-3/3K	SOT-23	DBV	5	3000	195.0	200.0	45.0
REG101NA-5/250	SOT-23	DBV	5	250	195.0	200.0	45.0
REG101NA-5/3K	SOT-23	DBV	5	3000	195.0	200.0	45.0
REG101NA-A/250	SOT-23	DBV	5	250	195.0	200.0	45.0
REG101NA-A/3K	SOT-23	DBV	5	3000	195.0	200.0	45.0
REG101UA-2.8/2K5	SOIC	D	8	2500	346.0	346.0	29.0
REG101UA-3.3/2K5	SOIC	D	8	2500	346.0	346.0	29.0
REG101UA-5/2K5	SOIC	D	8	2500	346.0	346.0	29.0

DBV (R-PDSO-G5)

PLASTIC SMALL-OUTLINE PACKAGE



- NOTES:
- A. All linear dimensions are in millimeters.
 - B. This drawing is subject to change without notice.
 - C. Body dimensions do not include mold flash or protrusion. Mold flash and protrusion shall not exceed 0.15 per side.
 - D. Falls within JEDEC MO-178 Variation AA.

D (R-PDSO-G8)

PLASTIC SMALL-OUTLINE PACKAGE

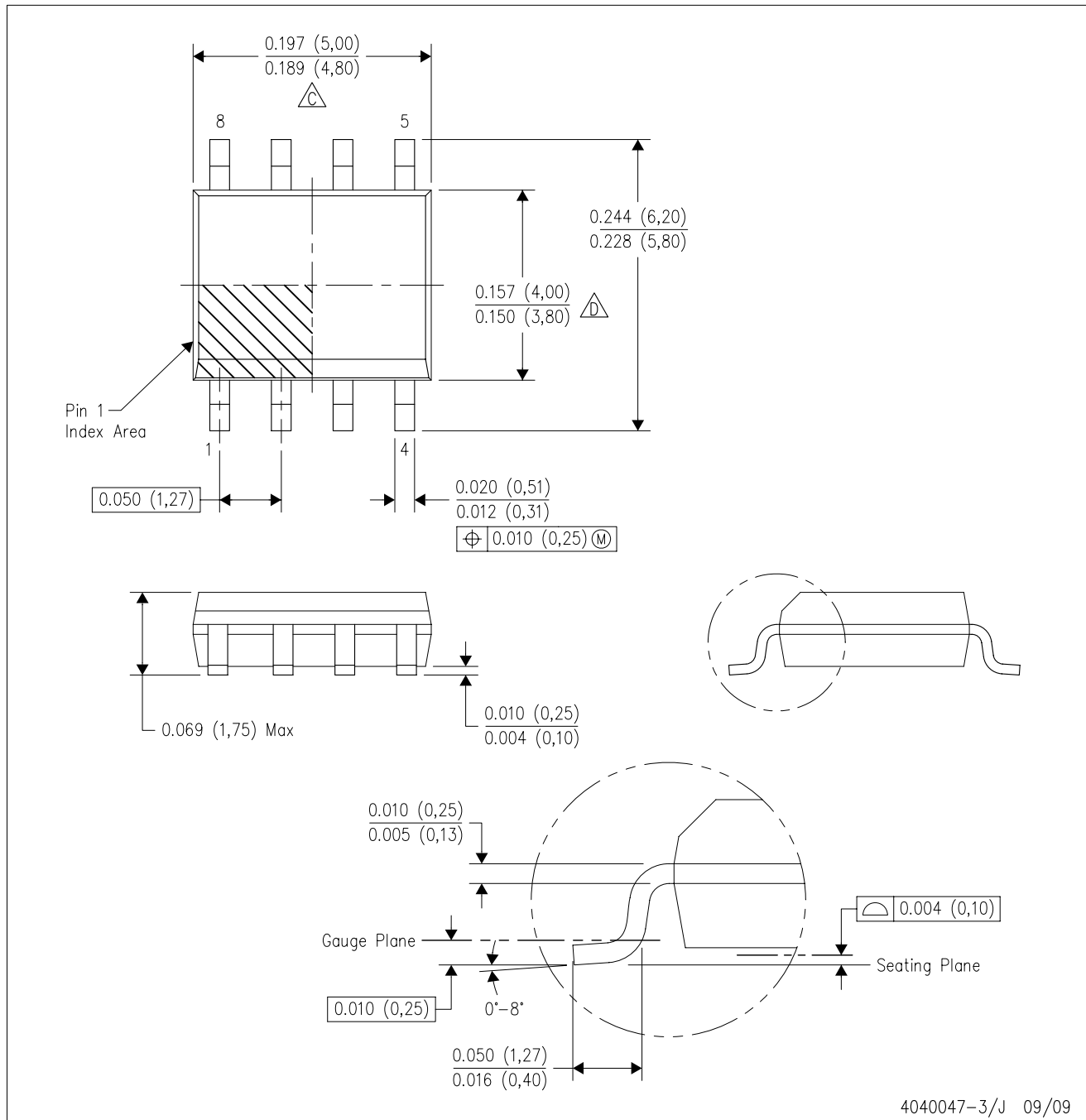

- NOTES:
- A. All linear dimensions are in inches (millimeters).
 - B. This drawing is subject to change without notice.
 - $\triangle C$ Body length does not include mold flash, protrusions, or gate burrs. Mold flash, protrusions, or gate burrs shall not exceed .006 (0,15) per end.
 - $\triangle D$ Body width does not include interlead flash. Interlead flash shall not exceed .017 (0,43) per side.
 - E. Reference JEDEC MS-012 variation AA.

IMPORTANT NOTICE

Texas Instruments Incorporated and its subsidiaries (TI) reserve the right to make corrections, modifications, enhancements, improvements, and other changes to its products and services at any time and to discontinue any product or service without notice. Customers should obtain the latest relevant information before placing orders and should verify that such information is current and complete. All products are sold subject to TI's terms and conditions of sale supplied at the time of order acknowledgment.

TI warrants performance of its hardware products to the specifications applicable at the time of sale in accordance with TI's standard warranty. Testing and other quality control techniques are used to the extent TI deems necessary to support this warranty. Except where mandated by government requirements, testing of all parameters of each product is not necessarily performed.

TI assumes no liability for applications assistance or customer product design. Customers are responsible for their products and applications using TI components. To minimize the risks associated with customer products and applications, customers should provide adequate design and operating safeguards.

TI does not warrant or represent that any license, either express or implied, is granted under any TI patent right, copyright, mask work right, or other TI intellectual property right relating to any combination, machine, or process in which TI products or services are used. Information published by TI regarding third-party products or services does not constitute a license from TI to use such products or services or a warranty or endorsement thereof. Use of such information may require a license from a third party under the patents or other intellectual property of the third party, or a license from TI under the patents or other intellectual property of TI.

Reproduction of TI information in TI data books or data sheets is permissible only if reproduction is without alteration and is accompanied by all associated warranties, conditions, limitations, and notices. Reproduction of this information with alteration is an unfair and deceptive business practice. TI is not responsible or liable for such altered documentation. Information of third parties may be subject to additional restrictions.

Resale of TI products or services with statements different from or beyond the parameters stated by TI for that product or service voids all express and any implied warranties for the associated TI product or service and is an unfair and deceptive business practice. TI is not responsible or liable for any such statements.

TI products are not authorized for use in safety-critical applications (such as life support) where a failure of the TI product would reasonably be expected to cause severe personal injury or death, unless officers of the parties have executed an agreement specifically governing such use. Buyers represent that they have all necessary expertise in the safety and regulatory ramifications of their applications, and acknowledge and agree that they are solely responsible for all legal, regulatory and safety-related requirements concerning their products and any use of TI products in such safety-critical applications, notwithstanding any applications-related information or support that may be provided by TI. Further, Buyers must fully indemnify TI and its representatives against any damages arising out of the use of TI products in such safety-critical applications.

TI products are neither designed nor intended for use in military/aerospace applications or environments unless the TI products are specifically designated by TI as military-grade or "enhanced plastic." Only products designated by TI as military-grade meet military specifications. Buyers acknowledge and agree that any such use of TI products which TI has not designated as military-grade is solely at the Buyer's risk, and that they are solely responsible for compliance with all legal and regulatory requirements in connection with such use.

TI products are neither designed nor intended for use in automotive applications or environments unless the specific TI products are designated by TI as compliant with ISO/TS 16949 requirements. Buyers acknowledge and agree that, if they use any non-designated products in automotive applications, TI will not be responsible for any failure to meet such requirements.

Following are URLs where you can obtain information on other Texas Instruments products and application solutions:

Products

Amplifiers	amplifier.ti.com
Data Converters	dataconverter.ti.com
DLP® Products	www.dlp.com
DSP	dsp.ti.com
Clocks and Timers	www.ti.com/clocks
Interface	interface.ti.com
Logic	logic.ti.com
Power Mgmt	power.ti.com
Microcontrollers	microcontroller.ti.com
RFID	www.ti-rfid.com
RF/IF and ZigBee® Solutions	www.ti.com/lprf

Applications

Audio	www.ti.com/audio
Automotive	www.ti.com/automotive
Broadband	www.ti.com/broadband
Digital Control	www.ti.com/digitalcontrol
Medical	www.ti.com/medical
Military	www.ti.com/military
Optical Networking	www.ti.com/opticalnetwork
Security	www.ti.com/security
Telephony	www.ti.com/telephony
Video & Imaging	www.ti.com/video
Wireless	www.ti.com/wireless

Mailing Address: Texas Instruments, Post Office Box 655303, Dallas, Texas 75265
Copyright © 2009, Texas Instruments Incorporated